



Connection options Angry Audio StudioHub HD Breakout Boxes

3 models to choose from*:

16-XLRF (16 female XLR)

16-XLRM (16 male XLR)

8-XLRF, 8-XLRM (8 female, 8 male XLR)

CBL4088: VHDCI to 4 x DB25



CBL4188: VHDCI to 2 x DB25, 2 x BNC, 1 x XLRF, 1 x Centronics (GPIO)

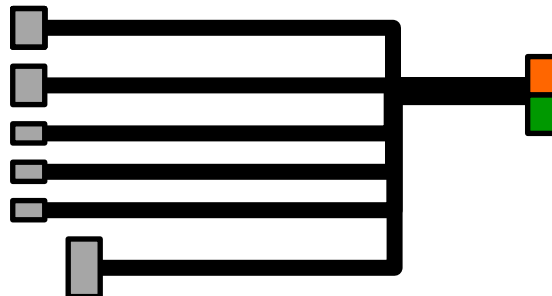

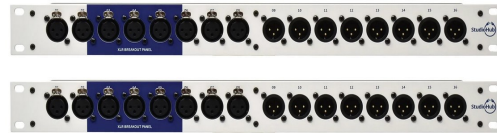

Analog



AES/EBU +
GPIO



-  Blue = Analog
-  Orange = AES/EBU
-  Green = GPIO

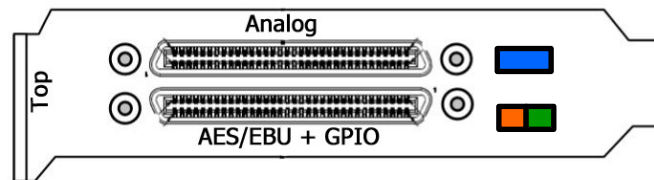

*Available direct from Angry Audio at angryaudio.com



Connection options

ASI5780/ASI5788 and ASI6788/ASI6718

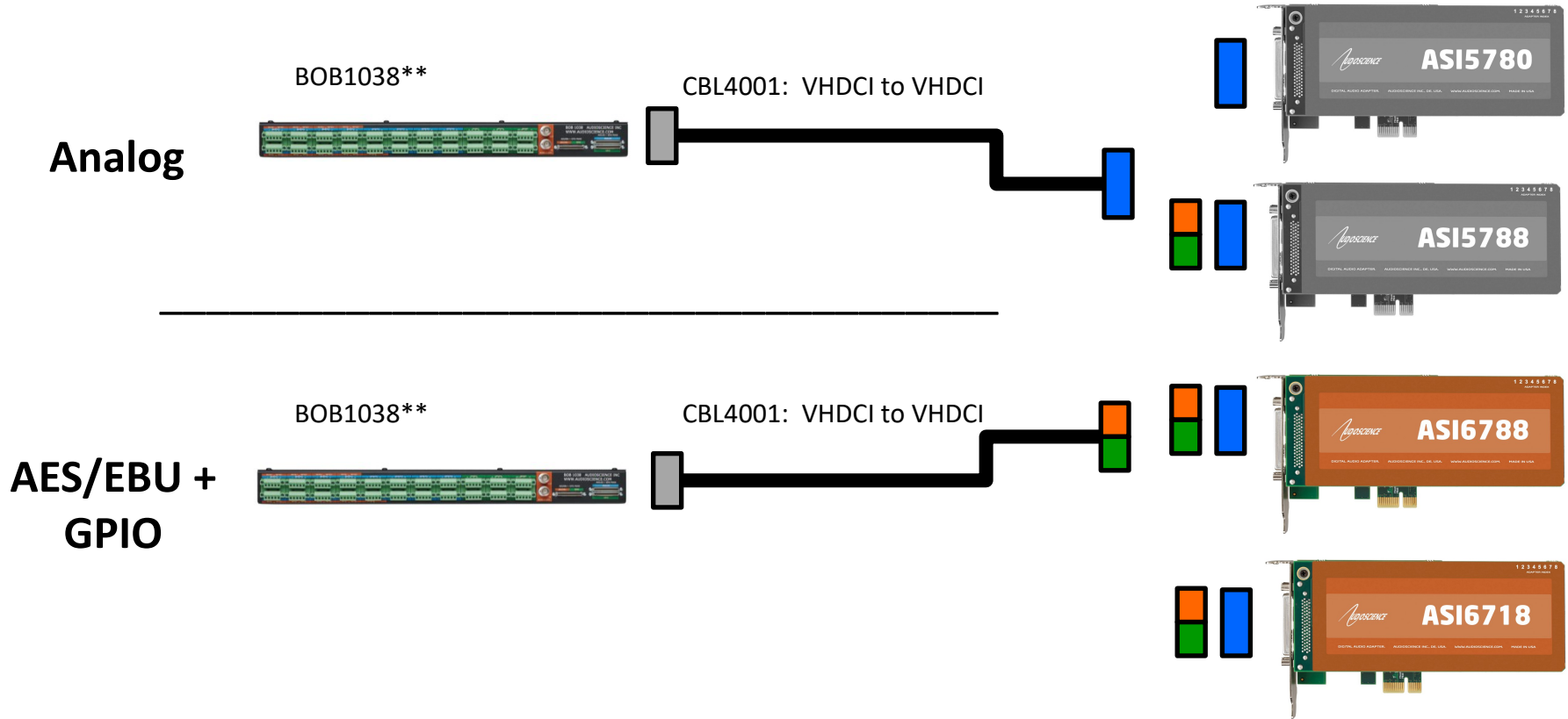

Blue = Analog Orange = AES/EBU Green = GPIO

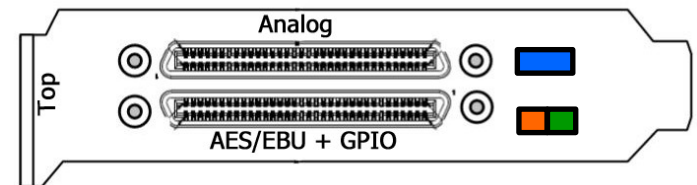

**Discontinued legacy product – See StudioHub replacement info