



ASI5812

LOW PROFILE PCI EXPRESS AUDIO ADAPTER

1 DESCRIPTION

The ASI5812 is a professional PCI Express (PCIe) audio adapter designed for use in radio broadcast FM MPX generation.

The ASI5812 offers two stereo record streams from either a balanced analog input or AES/EBU digital input and four stereo play streams mixed to a balanced analog output and two AES/EBU digital outputs.

The 2nd AES/EBU output includes a Sample Rate Converter (SRC) and independent sample rate clock.

The adapter also includes GPIO in the form of four opto-isolated inputs and two relay isolated outputs.

Breakout cable CBL1313 with XLR connectors is supplied.



2 FEATURES

- Four stereo streams of PCM playback
- Two stereo streams of PCM record
- Balanced stereo analog input and output with +24dBu I/O.
- PCI Express interface.
- GPIO: Four opto inputs and two relay outputs.
- One AES/EBU digital input with hardware Sample Rate Converter (SRC).
- Two AES/EBU digital outputs. 2nd output has SRC with independent sample rate clock
- 24bit analog-to-digital and digital-to-analog converters - 100dB SNR and 0.0025% THD+N
- 11 to 192kHz sample rates
- MRX™ multi rate mixing technology supports digital mixing of multiple sample rates
- SoundGuard™ transient voltage suppression protects against lightning and other high voltage surges on all I/O
- Up to 8 cards in one system
- Windows 10, 7, Server 2008/2012 and Linux drivers available

ASI5812

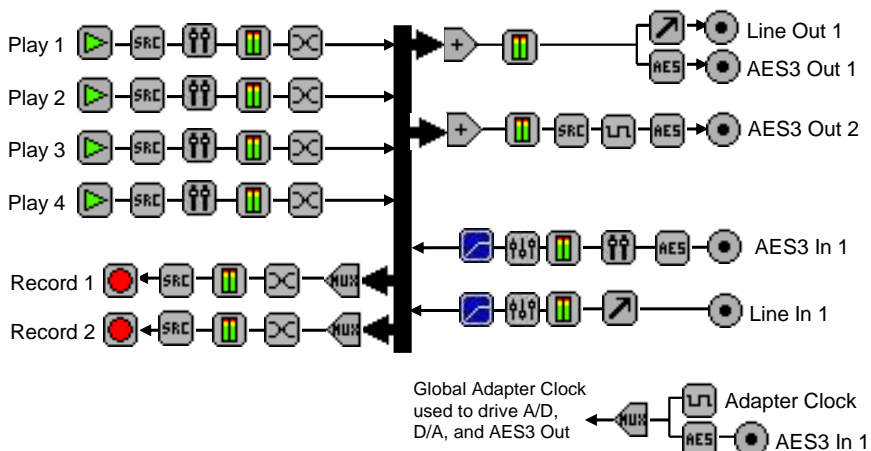

Key:

- | | | | |
|---------------|---------------|-----------------------|---------------|
| Record Stream | Level | Meter | Compressor |
| Play Stream | Mixer | Sample Rate Converter | Equalizer |
| Input/Output | Multiplexer | Channel Mode | Phantom Power |
| Volume | AES/EBU Tx/Rx | Clock Source | Mic Input |

3 SPECIFICATIONS

BALANCED INPUT/OUTPUT

Connector	DB-26HD Female with XLRs on breakout cable CBL1313.
Input Level	-10 to +24dBu in 1dBu steps
Input Impedance	20K ohms
Output Level	-10 to +24dBu in 1dBu steps
Load Impedance	600ohms or greater
Output Impedance	50ohms
Dynamic Range [1]	>=100dB (record or play)
THD+N [2]	=<-94dB (0.002%)(record or play)
Sample Precision	24bit Oversampling
Frequency Response	20Hz to 20kHz +/-0.5dB @ 48kHz (play/record) 20Hz to 40kHz +0.5/-1dB @ 96kHz (play/record) 20Hz to 80kHz +0.5/-3dB @ 192kHz (play) 20Hz to 67kHz +0.5/-3dB @ 192kHz (record)
Channel Crosstalk	-120dB
Channel phase mismatch	1.25degrees
Channel level mismatch	0.4dB

DIGITAL INPUT/OUTPUT

Type	AES3-1992 (EIAJ CP-340 Type I / IEC-958 Professional)
Connector	DB-26HD Female with XLRs on breakout cable CBL1313.
Sample Rates	32, 44.1, 48, 88.2, 96, 176.4 and 192kHz
Sample Precision	24bit

GPIO

Opto-isolated inputs

Isolation	2000VRMA
Input Drive	4mA typical with internal 5V supply and internal 1K current limiting resistor

Relay-isolated Outputs

Isolation	1500VRMS between relay contacts and coil
Contact Rating	Up to 220VDC/250VAC and 2A, 60W maximum

SAMPLE RATE CLOCK

Internal	32, 44.1, 48, 88.2, 96, 176.4 and 192kHz
AES/EBU In	32, 44.1, 48, 88.2, 96, 176.4 and 192kHz
AES/EBU Out 2	32, 44.1, 48, 88.2, 96, 176.4 and 192kHz

SIGNAL PROCESSING

DSP	Texas Instruments TMS320DM8147@600MHz
Memory	32MB
Audio Formats	8 bit unsigned PCM 16bit signed PCM 32bit IEEE floating point PCM

BREAKOUT CABLE (INCLUDED)

Analog+AES/EBU+GPIO	CBL1313: DB-26HD to 2 in / 2 out XLR (Analog), 1 in / 2 out XLR (AES/EBU) and DB15 Male (GPIO)
---------------------	--

GENERAL

Bus	X1 PCI Express.
Dimensions	Low profile PCI form factor – 4.375" x 2.75" x 0.6" (111mm x 70mm x 15mm)
Weight	8 oz (227g) max
Operating Temperature	0C to 70C
Power Requirements	+3.3V @ TBD, +12V @ TBD

[1] - Dynamic Range is the difference between a 1kHz digital full-scale sinewave and digital zero using an A weighting filter

[2] - THD+N measured using a +20dBu 1kHz sinewave sampled at 48kHz and A weighting filter

[3] - Using a 96kHz sampling rate

4 REVISIONS

Date	Description
16 June 2017	1 st draft

5 CONTENTS

1	DESCRIPTION	1
2	FEATURES	1
3	SPECIFICATIONS	2
4	REVISIONS	3
5	CONTENTS	4
6	CONNECTORS	5
6.1	DB-26HD: ANALOG, AES/EBU AND GPIO	5
7	BREAKOUT CABLE	5
7.1	GPIO DB15 PINOUTS AND CONNECTIONS	6
8	HARDWARE INSTALLATION	7
8.1	SETTING ADAPTER INDEX – ONE ADAPTER IN THE PC.....	7
8.1.1	<i>Setting Adapter Index - Two or More Adapters in the PC</i>	7
9	SOFTWARE INSTALLATION	7
9.1	DRIVERS FOR WINDOWS 10, 7, SERVER 2008, SERVER 2012.....	8
9.1.1	<i>Combo Driver</i>	8
9.1.2	<i>ASIO</i>	8
9.1.3	<i>Driver Failure</i>	8
9.2	DRIVERS FOR LINUX.....	8
9.3	APPLICATIONS FOR WINDOWS	8
9.3.1	<i>ASIControl</i>	8
10	OPERATION USING ASICONTROL	9
11	USER INTERFACE	9
11.1	ASICONTROL LAYOUT.....	9
11.1.1	<i>Adapter List Window</i>	9
11.1.2	<i>Adapter Topology Window</i>	9
11.1.3	<i>Node Controls Window</i>	10
11.2	CONTROLS.....	10
11.2.2	<i>Volume</i>	10
11.3	METER.....	11
11.3.1	<i>Interface</i>	11
11.3.2	<i>Developer</i>	11
11.4	CHANNEL_MODE	11
11.4.1	<i>Interface</i>	11
11.5	CLOCKSOURCEIN	12
11.5.1	<i>Interface</i>	12
11.6	ADAPTER SAMPLE RATE CLOCK AND MRX MIXER	13
11.7	AES/EBU OUTPUT 2 SAMPLE RATE CLOCK	13
11.7.1	<i>Developer</i>	14
12	AUDIO FORMATS	14
13	REFERENCES	15
13.1	SPECIFICATIONS	15

6 CONNECTORS

6.1 DB-26HD: Analog, AES/EBU and GPIO

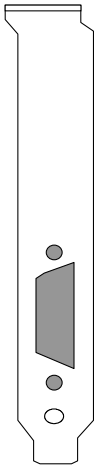

DB-26HD
(Female)

Line In Right + [26]
 Line In Right - [25]
 Line Out Right + [24]
 Line Out Right - [23]
 GPIO Opto 2 - [22]
 GPIO Opto 4 - [21]
 AES/EBU Out 1 + [20]
 AES/EBU Out 1 - [19]

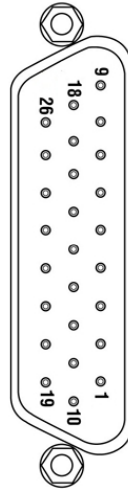

[9] AES/EBU Out 2 +
 [8] Analog Ground
 [7] Line In Left -
 [6] Line Out Left -
 [5] GPIO VOPT
 [4] GPIO Opto 1
 [3] GPIO Relay 1A
 [2] GPIO Relay 2A
 [1] AES/EBU In +
 [18] AES/EBU Out 2 -
 [17] Line In Left +
 [16] Line Out Left +
 [15] Digital Ground
 [14] GPIO +3.3V
 [13] GPIO Opto 3
 [12] GPIO Relay 1B
 [11] GPIO Relay 2B
 [10] AES/EBU In -

7 BREAKOUT CABLE

The ASI5812 breakout cable has p/n CBL1313. It breaks out the DB-26HD connector into the following:

- Left & Right Line Input on XLR female
- Left & Right Line Output on XLR male
- AES/EBU Input on XLR female
- AES/EBU Outputs on XLR male
- GPIO on DB-15

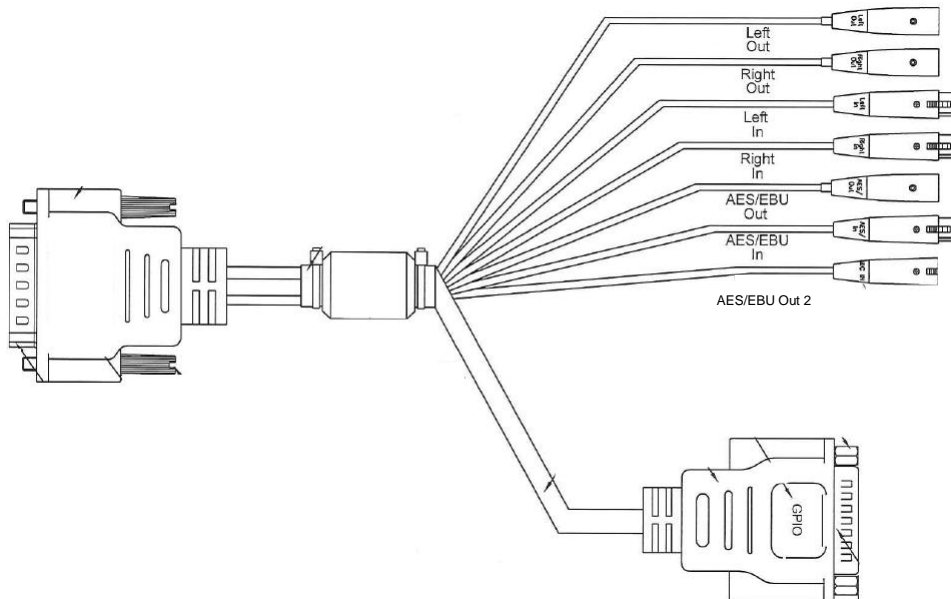

7.1 GPIO DB15 Pinouts and Connections

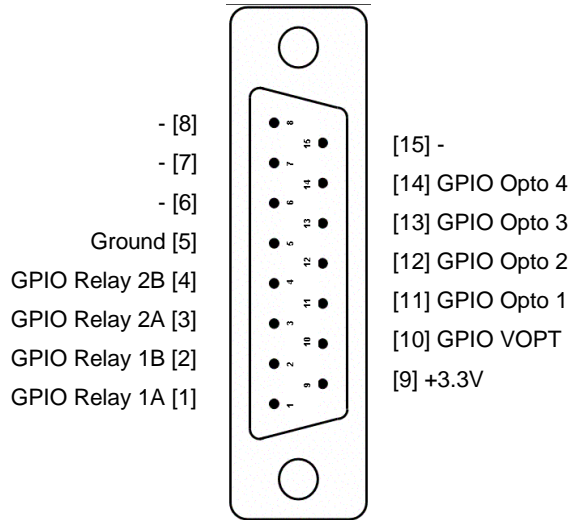

The following diagrams show how to connect the GPIO for isolated and non-isolated cases

Isolated

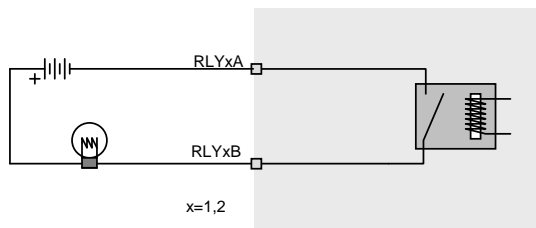

External switch

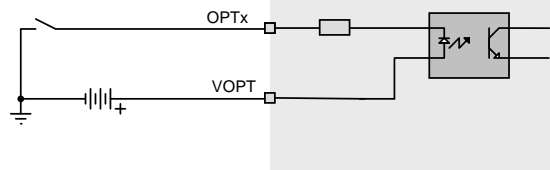

TTL Compatible Non-isolated

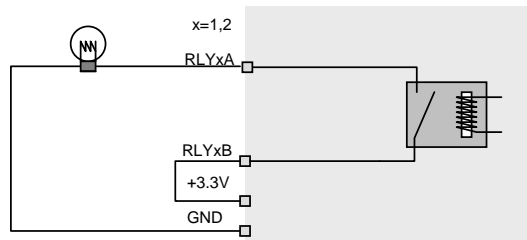

External switch

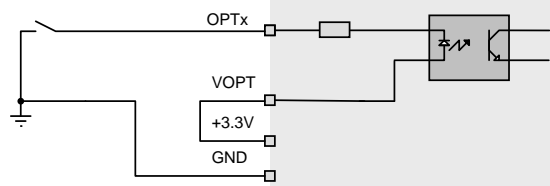

8 HARDWARE INSTALLATION

This section explains how to install one or more AudioScience adapters in a computer.

8.1 Setting Adapter Index – One Adapter in the PC

1. Make sure your computer is turned off.
2. PCI adapters should be installed in any empty PCI slot and PCIe adapters should be installed in any x1 (or greater) PCIe slot.
3. Make sure the adapter jumper is set to adapter index #1, the factory default. For a new card no changes need to be made. For an AudioScience adapter from another installation, check that it is set to adapter index #1.

Depending on the adapter family, there are different ways of setting the adapter index.

For ASI5000 and ASI6000 families, there is an adapter jumper that must be set. The left most position represents adapter index #1.

For ASI5300, ASI6300, ASI8700, and ASI8900 families, there is a rotary switch.

NOTE: Position 0 (zero) represents adapter #1, position 1 is adapter #2, etc.

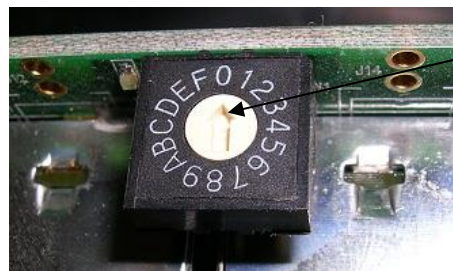
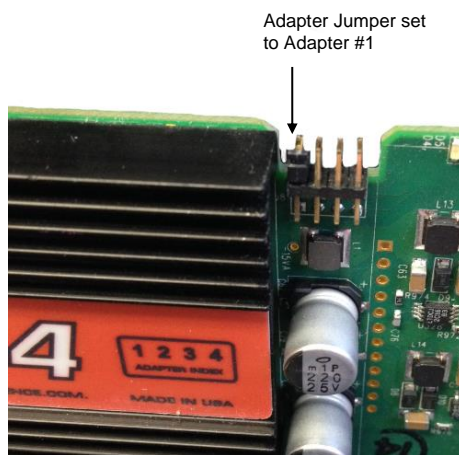

4. Turn on the computer and let it boot. Under Windows, a dialog box will pop up informing you that the computer has detected a new Multimedia Audio card. Cancel out of this dialog box and proceed to the software installation section of this datasheet.

8.1.1 Setting Adapter Index - Two or More Adapters in the PC

1. Make sure your computer is turned off.
2. PCI adapters should be installed in any empty PCI slots and PCIe adapters should be installed in any x1 (or greater) PCIe slots. Different adapter types can coexist in the same computer; for example, an ASI6416 and ASI8921 will work correctly if installed in the same PC. Different adapter types still require unique adapter index numbers.
3. Each adapter in the PC needs to have its adapter jumper/rotary switch position set to unique numbers. For example if you are installing two adapters, the first one would be set to adapter index #1 and the second to adapter index #2.
 - 3.1. For ASI5000 and ASI6000 families, the position to the right of index #1, when jumpered, represents adapter index #2. The next position represents #3, and the rightmost position, when jumpered, represents #4.
 - 3.2. For ASI5300, ASI6300, ASI8700, and ASI8900 families, rotate the rotary switch to indicate what position is required.

9 SOFTWARE INSTALLATION

AudioScience makes audio adapters and drivers for various operating systems. Enhancements to an adapter's utility come from the integrators software that uses the audio driver to implement sophisticated audio playback and recording functions.

9.1 Drivers for Windows 10, 7, Server 2008, Server 2012

Typically, drivers are not included with the hardware and will need to be downloaded from the AudioScience website. They can be found here: http://www.audioscience.com/internet/download/win_drivers.htm

The first step is to determine what type of driver is needed for your operating system. Drivers are available for 32-bit and 64-bit Windows systems.

Driver 3.10 and later present the user with three install options during installation:

- Install Standard PCI/PCIe Driver.
- Install Standard + Network Audio Driver.
- Remove all driver components

Traditional installs should select the first of these options. Users of AudioScience CobraNet and AVB products should select the second option with the “+Network Audio Driver.” in the text.

9.1.1 Combo Driver

The Combo driver installs WDM devices by default and presents an option to “Install legacy 32-bit WAVE driver” in case your application requires it. Download the file named ASICOMBO_XXXXXX.EXE from www.audioscience.com and run it (_XXXXXX is the version number). After the EXE has run, reboot your computer and the audio adapter will be operational. If the cover is off the computer, one can see one or two blinking LEDs on top of the card indicating its DSP is running and communicating with the driver.

Verify that the adapter is running using ASIControl (see ASIControl section in this document).

9.1.2 ASIO

All AudioScience drivers also install an ASIO driver interface. It is installed by default.

9.1.3 Driver Failure

In the event that an adapter’s driver fails to load correctly, the OS’s event viewer should be checked. The event log is accessed from the Administrative Tools applet in Windows Control Panel under Event Viewer. The Windows Logs\System view should be selected.

If two or more adapters are installed in the same system, the first thing to check is that the adapters were assigned unique adapter numbers. If issues persist, please email support@audioscience.com.

9.2 Drivers for Linux

The latest Linux driver can be downloaded from the AudioScience website – www.audioscience.com

9.3 Applications for Windows

AudioScience provides ASIControl for adapter set-up and configuration.

9.3.1 ASIControl

All Windows drivers install an AudioScience application called ASIControl that can be used to setup and verify functionality of adapters. ASIControl provides a common interface for users across all driver types.

From the Windows Start menu, navigate to Start→Programs→AudioScience and run the ASIControl program.



10 OPERATION USING ASICONTROL

Using ASIControl, the ASI5812 will look similar to this:

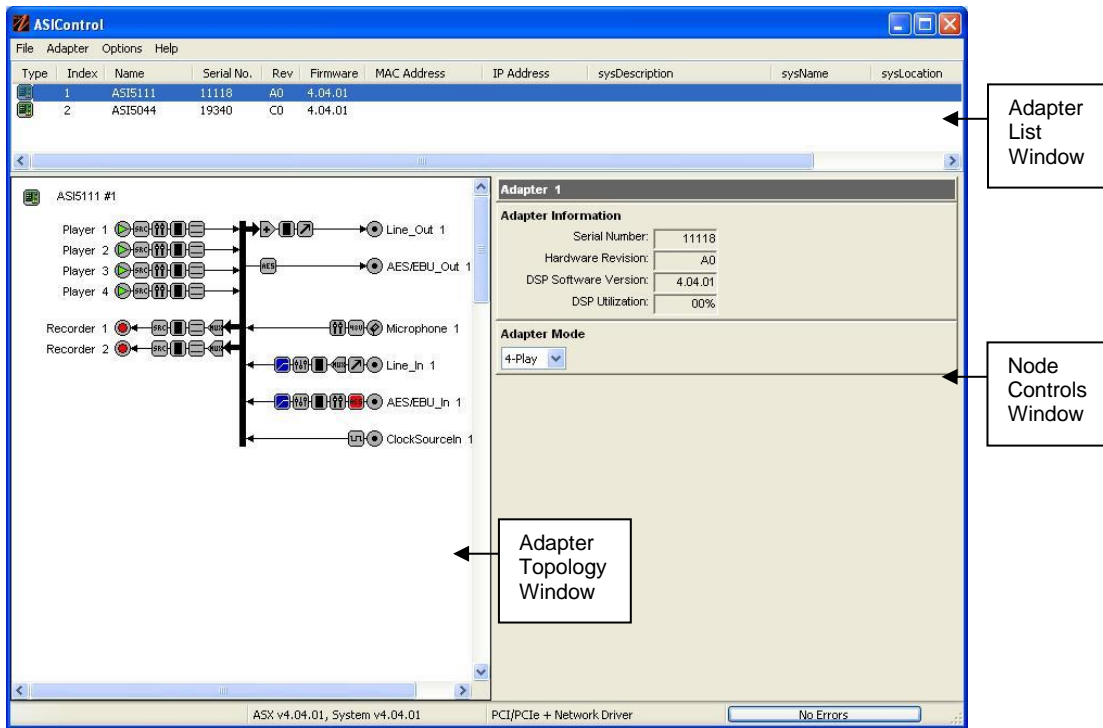

11 USER INTERFACE

11.1 ASIControl Layout

ASIControl consists of three main windows: the adapter list in the top portion of the window, the adapter topology view on the left hand side, and the node control list on the right hand side.

11.1.1 Adapter List Window

The top portion of ASIControl shows a list of all the adapters that the application has found. By default, only bus based (i.e. PCI and/or PCI Express) adapters will be shown. If the network portion of the driver is installed (by selecting "Install Standard + Networked Audio Driver" after running the driver installer) and "Local PCI(e) + Networked adapters" is selected from ASIControl's Options→Configure adapter interface, then AudioScience and other third party CobraNet devices will be shown.

Adapters are listed in order of adapter index. For bus-based adapters, this is determined by the adapter index jumper on the card. For AudioScience CobraNet devices this is calculated from the unit's MAC address. Third party CobraNet devices are listed last as they have no AudioScience index.

11.1.2 Adapter Topology Window

The left hand side of ASIControl contains the topology view of the adapter. It is essentially a block diagram of the device showing the available physical inputs and outputs on the right hand side of the black, vertical 'bus' line. On the left hand side of the bus line, bus-based adapters show player and recorder streams, while CobraNet adapters show their network connections.

Each of the inputs and outputs is referred to as a node and each Node contains one or more controls. The topology shows each control as a small icon. A non-exhaustive list of nodes follows:

Line In	Player	CobraNet In
Line Out	Recorder	CobraNet Out
AES/EBU In	Tuner	
AES/EBU Out	Clock Source In	

Hovering the mouse over a particular node will highlight it. Clicking on a node will bring up the controls resident on that node in the right hand control list.

There is an adapter node in the top left corner of the topology window. Clicking on this will show adapter-specific controls and properties on the right hand side. Not all adapters have all nodes.

11.1.3 Node Controls Window

The right hand side of ASIControl shows the controls associated with the selected node in the topology view. The controls are arranged, from top to bottom, in order of audio signal flow, i.e. the audio signal can be viewed as entering the node at the top control and leaving at the bottom control. Controls may be used to either manipulate the audio as it passes through the node, or report back control status information.

For a comprehensive listing of controls and how to operate ASIControl, please see the ASIControl manual available from www.audioscience.com and also installed by the driver. Not all adapters have all controls. The section below lists some common and any specific controls, as seen in ASIControl, for this adapter.

11.2 Controls

The ASI5812 supports three adapter modes: 1-Play, 4-Play and Low Latency.

11.2.1.1 1-Play

This mode supports 1 Play stream and 1 record stream.

11.2.1.2 4-Play

This mode supports 4 Play streams and 2 Record streams with full mixing capabilities.

11.2.2 Volume

The Volume control allows the audio signal's gain to be altered in the range of -100 to $+20$ dB.

11.2.2.1 Interface

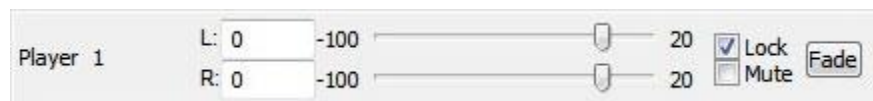

A Player volume in ASIControl.

Left and Right display boxes:

Displays the gain settings that the slider bars are set to.

Slider Bars:

Click on the bar with the mouse and drag to desired gain. Once the bars are selected, the left and right arrow keys can also be used to change the settings.

Lock:

When checked, locks the left and right channels to the same gain value. When unchecked, allows the left and right channels to have independent gains. (Note that if an adapter is in SSX2 mode, the Player volumes cannot be unlocked to move the left and right channels independently.)

Mute:

Check this box to mute the volume.

Fade:

When pressed, automatically fades the volume to the opposite end of the scale.

11.2.2.2 Developer

11.2.2.2.1 Windows APIs

Wave/Mixer – MIXERCONTROL_CONTROLTYPE_VOLUME

This is a Windows standard volume control. Settings are in the range of 0 to 65535, where 0 completely mutes the output and 65535 is the maximum volume.

HPI – [HPI_Volume](#) APIs.

ASX – [ASX_Volume](#) APIs.

DirectSound – TBD.

11.2.2.2 Linux APIs

HPI – [HPI Volume](#) APIs.

ASX – [ASX Volume](#) APIs.

ALSA – TBD.

11.3 Meter

Meters in ASIControl are located on audio nodes and display the audio level as the audio signal passes through the node. Most AudioScience devices return both RMS and peak level readings and ASIControl displays both simultaneously.

11.3.1 Interface

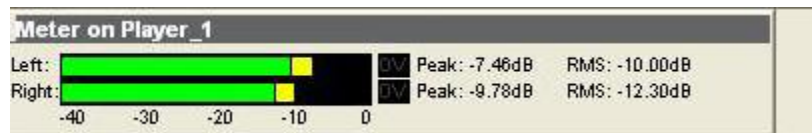

A stereo peak meter display. The RMS is the green bar and the peak is the yellow bar.

To the right of the peak meter is the absolute readings in dBFS. These can be useful when testing input tones of a specific known level.

11.3.2 Developer

11.3.2.1 Windows APIs

Wave/Mixer – Meters are read using `mixerGetControlDetails()` on a control of type signed and with type “Peak” the name “Peak Meter”. A minimum value is 0 and maximum is 32767. The interface returns the peak readings only, not the RSM level. It confirms to expected Windows functionality.

HPI – Meters are read using the [HPI Meterxxx\(\)](#) API.

ASX – Meters are read using the [ASX Meter xxx\(\)](#) API.

DirectSound – TBD.

11.3.2.2 Linux APIs

HPI – Meters are read using the [HPI Meterxxx\(\)](#) API.

ASX – Meters are read using the [ASX Meter xxx\(\)](#) API.

ALSA – TBD.

11.4 Channel_Mode

The channel mode is a mechanism for handling mono to stereo conversions and directing the output to either left or right channels, as well as outputting left to stereo and right to stereo.

11.4.1 Interface

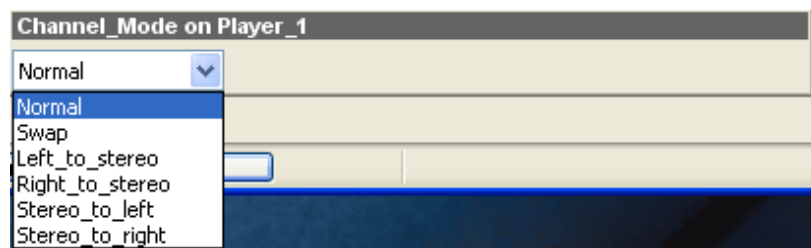

ASIControl view of a player’s channel mode control.

Default playback of either mono or stereo files causes audio to be output from the player on both the left and right audio channels. The channel mode control can allow the audio to be directed to either the left only or the right only. Select a channel mode setting from the dropdown list.

Valid settings are:

Normal – left channel out left channel, right channel out right channel

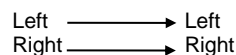

Swap – left channel out right channel and right channel out left channel



Left_to_stereo – left channel out to both left and right channels

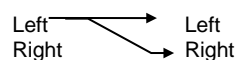

Right_to_stereo – right channel out to both left and right channels

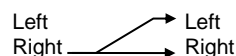

Stereo_to_left – left and right channels out to left channel

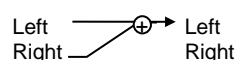

Stereo_to_right – left and right channels out to right channel



The Stereo_to_left and Stereo_to_right operations perform a sum of the left and right channels and then divides the result by 2

11.5 ClockSourceIn

In the topology pane of ASIControl, click on Clock Source 1

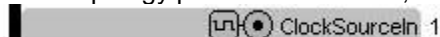

and in the node pane, select where the adapter is to get its clock source from using the Clock Source dropdown list, as well as the sample rate to use if clocking from adapter.

Note that for CobraNet and Livewire devices, the sample rate is fixed at 48kHz.

11.5.1 Interface



Clock Source information as seen in ASIControl.

Local Rate:

Select from the dropdown list the supported rates of the adapter.

Clock Source:

From the dropdown list, select the source for the adapter's clocking. Selections, depending on the adapter, include:

- Local – adapter rate is used; select a supported sample rate in Local Rate dropdown list
- Word – Word clock from Word clock BNC connector on digital cable loom (or BOB1024)
- WordHeader – Word clock from header on adapter (ASI61xx only)

- AES/EBU Sync – AES/EBU Sync from AES/EBU Sync XLR connector on digital cable loom (or BOB1024)
- AES/EBU In 1-4 – rate taken from specific digital input
- AES/EBU Auto – rate taken from first valid digital input; looks at digital input 1 first, then up to digital input 4
- Blu link

Adapter Rate:

Displays the current adapter operating rate

11.5.1.1 Low Latency
11.6 Adapter Sample Rate Clock and MRX Mixer

The ASI5812 adapter sample rate clock is used to drive the MRX digital mixer, Analog to Digital Converter (ADC), Digital to Analog Converter (DAC) and the 1st AES/EBU output. There are two sources of sample rate clock – internal and the AES/EBU input.

The internal adapter clock is generated from a low jitter frequency synthesizer and may be set to 32, 44.1, 48, 88.2, 96kHz and 192kHz.

Note that the sample rate clock does not determine the sample rates of the audio streams that may be played and recorded. These are independently set using the MRX multi rate mixer, so that, for instance, you can have the adapter running at 96kHz, but be playing files of 44.1 and 48kHz and recording files of 32 and 88.2kHz.

In ASIControl, click on the ClockSourceIn 1 node in the topology pane to access the Local Rate, Clock Source, and Adapter Rate. Local Rate is used to select the internal adapter rate.

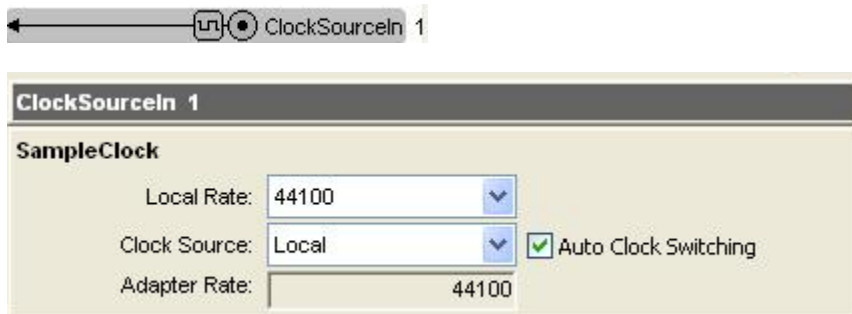
11.7 AES/EBU Output 2 Sample Rate Clock

The ASI5812's 2nd AES/EBU output has an independent sample rate clock. The audio from the mixer (running at the Adapter Sample Rate) passes through a sample rate converter (SRC) before being output at this rate. In ASIControl, click on the AES/EBU Output 2 node to access its Sample rate Clock

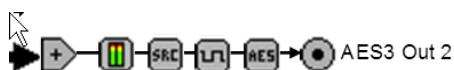

11.7.1 Developer

11.7.1.1 Windows APIs

HPI – Use the HPI_SampleClock_XXXX APIs.

12 AUDIO FORMATS

The ASI5811 supports record and play of the following formats:

Format	HPI format	Windows format
8 bit unsigned PCM	HPI_FORMAT_PCM8_UNSIGNED	WAVE_FORMAT_PCM, wBitsPerSample=8
16 bit signed PCM	HPI_FORMAT_PCM16_SIGNED	WAVE_FORMAT_PCM, wBitsPerSample=16
32 bit signed PCM	HPI_FORMAT_PCM32_SIGNED	WAVE_FORMAT_PCM, wBitsPerSample=32
32 bit floating point PCM (+/-1.0)	HPI_FORMAT_PCM32_FLOAT	WAVE_FORMAT_IEEE_FLOAT

13 REFERENCES

13.1 Specifications

SPCWAVX.PDF - [WavX - AudioScience Windows Multimedia Extensions](#)

SPCHPI.PDF - [Hardware Programming Interface \(HPI\) Specification](#)

All these documents are available from www.audioscience.com in the Technical Info section