

## 1 DESCRIPTION

The ASI6522 and ASI6520 are professional PCI sound cards designed for use in radio broadcast automation.

Providing 4 or 6 play streams that are mixed to 2 balanced stereo outputs and 2 or 4 record streams fed from 2 balanced stereo inputs, the ASI6522 and ASI6520 feature AudioScience's unique "anything to anywhere" mixing and routing.

The ASI6522 provides both balanced analog and AES/EBU inputs and outputs. The ASI6520 has analog I/O only. The maximum analog input and output level is +24dBu.

A choice of uncompressed PCM, MPEG layer 2 and MP3 is available for both recording and playback. All compression is handled by an on-board floating point DSP, allowing the host computer to focus on other tasks.

DSP based functionality includes MRX™ multi-rate mixing technology, which allows streams of different, sample-rates and formats to be mixed digitally. TSX™ time scaling allows compression/expansion of any or all playback streams in real time with no change in pitch.



**MRX**  
MULTI-RATE MIXING

**SOUND GUARD**

**MP3**

**TSX**



## 2 FEATURES

- 4 or 6 stereo streams of playback into 2 stereo outputs
- 2 or 4 stereo streams of record from 2 stereo inputs
- Supported formats: PCM, MPEG layer 2 and MP3 with sample rates to 96kHz
- MRX™ technology supports digital mixing of multiple stream formats and sample rates
- TSX™ time scaling allows compression/expansion of play streams by up to +/-20% with no pitch shift
- Balanced stereo analog inputs and outputs with levels to +24dBu
- 24bit ADC and DAC with 110dB SNR and 0.0015% THD+N
- AES/EBU inputs and outputs with sample rate converters on all inputs (ASI6522 only)
- Dedicated AES/EBU and Word clock Sync input (ASI6522 only)
- SoundGuard™ transient voltage suppression on all I/O
- Short length PCI card format (6.5 inches/165mm)
- Up to 4 cards in one system
- Windows 8, 7, Server 2008/2012, and Linux drivers available

ASI6522, ASI6520

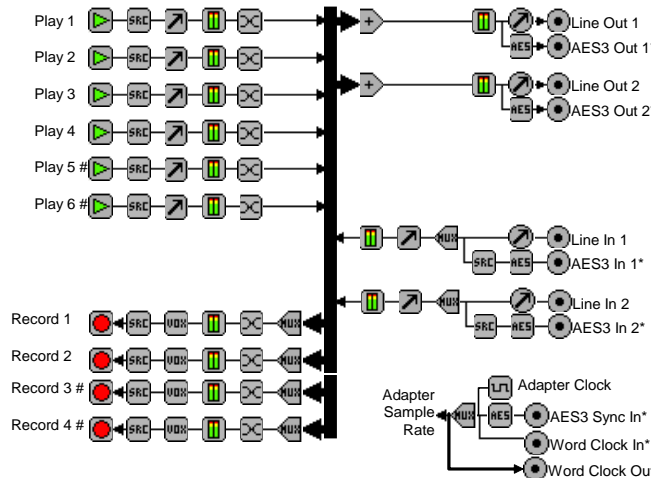

\* ASI6522 Only  
# Available in 6 Play/4 Record stream mode

- Key:
- Record Stream
  - Play Stream
  - Input/Output
  - Volume
  - Level
  - Mixer
  - Multiplexer
  - AES/EBU Tx/Rx
  - Meter
  - Sample Rate Converter
  - Channel Mode
  - Clock Source

### 3 SPECIFICATIONS

#### ANALOG INPUT/OUTPUT

Type	Balanced
Connector	Mini50 (SCSI-II type)
Input Level	-10 to +24dBu in 0.5dBu steps
Input Impedance	10K ohms
A/D converter	24bit oversampling
Output Level	-10 to +24dBu in 0.5dBu steps
D/A converter	24bit oversampling
Load Impedance	600ohms or greater
Dynamic Range [1]	>110dB (record or play)
THD+N [1]	<-96dB (0.0015%) (record or play)
Frequency Response	20Hz to 20kHz +0/-0.2dB 20Hz to 40kHz +0/-3dB
Inter-channel Phase	<0.1 degrees (record or play)
Inter-channel Crosstalk	>110dB (record or play)

#### DIGITAL INPUT/OUTPUT [2]

Type	AES/EBU (EIAJ CP-340 Type I / IEC-958 Professional)
Input/Output Impedance	110 ohms
Connector	Mini26 (SCSI-II type)
Sample Rates	32, 44.1, 48, 88.2 and 96kHz with sample rate converters on inputs

#### SAMPLE RATE CLOCK

Internal (Adapter)	32, 44.1 48, 88.2 and 96kHz
AES/EBU Sync In [2]	32, 44.1 48, 88.2 and 96kHz on dedicated AES/EBU input
Word In [2]	32, 44.1 48, 88.2 and 96kHz
Word Out [2]	32, 44.1 48, 88.2 and 96kHz

#### SIGNAL PROCESSING

DSP	Texas Instruments TMS320C6713@300MHz
Memory	8MB
Audio Formats	8 bit unsigned PCM 16 bit signed PCM 32 bit floating point PCM MPEG-1 Layer 2 MPEG-1 Layer 3(MP3) (MPEG Layer-3 audio coding technology licensed from Fraunhofer IIS and THOMSON multimedia)

#### BREAKOUT CABLES (NOT INCLUDED)

Analog	CBL1022: Mini DB50 to 4 XLR in and 4 XLR out
Digital [2]	CBL1122: Mini DB26 to 2 in, 2 out XLR, 1 BNC in, 1 BNC out (Word Clock)

#### GENERAL

Bus	32bit Universal PCI. PCI-X compatible.
Dimensions	PCI short-length form factor – 6.5" x 3.9" x 0.6" (165mm x 100mm x 15mm)
Weight	8 oz (227g) max
Operating Temperature	0C to 70C
Power Requirements	+3.3V@1.5A +12V @ 250mA

[1] Dynamic Range and THD+N measured using a +24dBu 1kHz sine wave sampled at 48kHz and A weighting filter.  
[2] ASI6522 Only

## 4 REVISIONS

Date	Description
05 October 2006	Preliminary.
07 January 2010	Page 1: Updated list of software drivers available. Added Mono and SSX2 mode sections.
22 July 2011	Updated format. Added Low Latency section.
24 May 2013	Fixed mode diagram on page 1
17 Sept 2013	Corrected numbering error in mode view diagrams
10 Jan 2014	Edited card dimensions
19 November 2014	Updates operating system and install instructions

## 5 CONTENTS

<b>1</b>	<b>DESCRIPTION</b> .....	<b>1</b>
<b>2</b>	<b>FEATURES</b> .....	<b>1</b>
<b>3</b>	<b>SPECIFICATIONS</b> .....	<b>2</b>
<b>4</b>	<b>REVISIONS</b> .....	<b>3</b>
<b>5</b>	<b>CONTENTS</b> .....	<b>4</b>
<b>6</b>	<b>HARDWARE INSTALLATION</b> .....	<b>5</b>
6.1	SETTING ADAPTER INDEX – ONE ADAPTER IN THE PC.....	5
6.1.1	<i>Setting Adapter Index - Two or More Adapters in the PC</i>	5
<b>7</b>	<b>SOFTWARE INSTALLATION</b> .....	<b>6</b>
7.1	DRIVERS FOR WINDOWS 8, 7, SERVER 2008, SERVER 2012.....	6
7.1.1	<i>Combo Driver</i>	6
7.1.2	<i>ASIO</i>	6
7.1.3	<i>Driver Failure</i>	6
7.2	DRIVERS FOR LINUX.....	6
7.3	APPLICATIONS FOR WINDOWS.....	7
7.3.1	<i>ASIControl</i>	7
<b>8</b>	<b>OPERATION USING ASICONTROL</b> .....	<b>7</b>
<b>9</b>	<b>USER INTERFACE</b> .....	<b>7</b>
9.1.1	<i>Adapter List Window</i>	8
9.1.2	<i>Adapter Topology Window</i>	8
9.1.3	<i>Node Controls Window</i>	8
9.1.4	<i>Adapter Information</i>	8
9.1.5	<i>Interface</i>	9
9.2	ADAPTER MODE.....	9
9.2.1	<i>Interface</i>	9
9.3	PLAYER.....	10
9.3.1	<i>Interface</i>	10
9.3.2	<i>How To Play a File</i>	10
9.3.3	<i>Using embedded sine wave generator</i>	10
9.3.4	<i>Developer</i>	11
9.4	RECORDER.....	11
9.4.1	<i>Interface</i>	11
9.4.2	<i>How To Record a File</i>	11
9.4.3	<i>Developer</i>	12
<b>10</b>	<b>AUDIO FORMATS</b> .....	<b>12</b>
10.1	VOLUME.....	12
10.1.1	<i>Interface</i>	12
10.1.2	<i>Developer</i>	13
10.2	METER.....	13
10.2.1	<i>Interface</i>	13
10.2.2	<i>Developer</i>	13
10.3	CHANNEL_MODE.....	14
10.3.1	<i>Interface</i>	14
10.4	CLOCKSOURCEIN.....	14
10.4.1	<i>Interface</i>	15

## 6 HARDWARE INSTALLATION

This section explains how to install one or more AudioScience adapters in a computer.

### 6.1 Setting Adapter Index – One Adapter in the PC

1. Make sure your computer is turned off.
2. PCI adapters should be installed in any empty PCI slot and PCIe adapters should be installed in any x1 (or greater) PCIe slot.
3. Make sure the adapter jumper is set to adapter index #1, the factory default. For a new card no changes need to be made. For an AudioScience adapter from another installation, check that it is set to adapter index #1.

Depending on the adapter family, there are different ways of setting the adapter index.

For ASI5000 and ASI6000 families, there is an adapter jumper that must be set. The left most position represents adapter index #1.

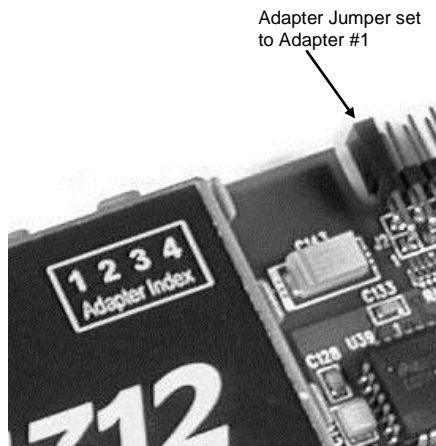

For ASI5300, ASI6300, ASI8700, and ASI8900 families, there is a rotary switch.

**NOTE:** Position 0 (zero) represents adapter #1, position 1 is adapter #2, etc.

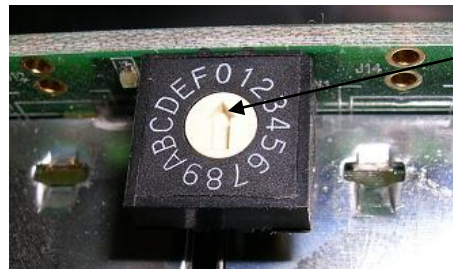

4. Turn on the computer and let it boot. Under Windows, a dialog box will pop up informing you that the computer has detected a new Multimedia Audio card. Cancel out of this dialog box and proceed to the software installation section of this datasheet.

#### 6.1.1 Setting Adapter Index - Two or More Adapters in the PC

1. Make sure your computer is turned off.
2. PCI adapters should be installed in any empty PCI slots and PCIe adapters should be installed in any x1 (or greater) PCIe slots. Different adapter types can coexist in the same computer; for example, an ASI6416 and ASI8921 will work correctly if installed in the same PC. Different adapter types still require unique adapter index numbers.
3. Each adapter in the PC needs to have its adapter jumper/rotary switch position set to unique numbers. For example if you are installing two adapters, the first one would be set to adapter index #1 and the second to adapter index #2.
  - 3.1. For ASI5000 and ASI6000 families, the position to the right of index #1, when jumpered, represents adapter index #2. The next position represents #3, and the rightmost position, when jumpered, represents #4.
  - 3.2. For ASI5300, ASI6300, ASI8700, and ASI8900 families, rotate the rotary switch to indicate what position is required.
4. Turn on the computer and let it boot. Under Windows, a dialog box will pop up informing you that the computer has detected a new Multimedia Audio card. Cancel out of this dialog box and proceed to the software installation section of this datasheet.

## 7 SOFTWARE INSTALLATION

AudioScience makes audio adapters and drivers for various operating systems. Enhancements to an adapter's utility come from the integrators software that uses the audio driver to implement sophisticated audio playback and recording functions.

### 7.1 Drivers for Windows 8, 7, Server 2008, Server 2012

Typically, drivers are not included with the hardware and will need to be downloaded from the AudioScience website. They can be found here: [http://www.audioscience.com/internet/download/win\\_drivers.htm](http://www.audioscience.com/internet/download/win_drivers.htm)

The first step is to determine what type of driver is needed for your operating system. Drivers are available for 32-bit and 64-bit Windows systems.

Driver 3.10 and later present the user with three install options during installation:

- Install Standard PCI/PCIe Driver.
- Install Standard + Network Audio Driver.
- Remove all driver components

Traditional installs should select the first of these options. Users of AudioScience CobraNet and AVB products should select the second option with the "+Network Audio Driver." in the text.

#### 7.1.1 Combo Driver

The Combo driver installs WDM devices by default and presents an option to "Install legacy 32-bit WAVE driver" in case your application requires it. Download the file named ASICOMBO\_XXXXXX.EXE from [www.audioscience.com](http://www.audioscience.com) and run it (\_XXXXXX is the version number). After the EXE has run, reboot your computer and the audio adapter will be operational. If the cover is off the computer, one can see one or two blinking LEDs on top of the card indicating its DSP is running and communicating with the driver.

Verify that the adapter is running using ASIControl (see ASIControl section in this document).

#### 7.1.2 ASIO

All AudioScience drivers also install an ASIO driver interface. It is installed by default.

#### 7.1.3 Driver Failure

In the event that an adapter's driver fails to load correctly, the OS's event viewer should be checked. The event log is viewed as follows:

7: The system event log is accessed from \Start\Control Panel\System and Maintenance\Administrative Tools\Event Viewer. The Windows Logs\System view should be selected.

If two or more adapters are installed in the same system, the first thing to check is that the adapters were assigned unique adapter numbers. If issues persist, please email [support@audioscience.com](mailto:support@audioscience.com).

### 7.2 Drivers for Linux

The latest Linux driver can be downloaded from the AudioScience website – [www.audioscience.com](http://www.audioscience.com)

### 7.3 Applications for Windows

AudioScience provides ASIControl for adapter set-up and configuration.

#### 7.3.1 ASIControl

All Windows drivers install an AudioScience application called ASIControl that can be used to setup and verify functionality of adapters. ASIControl provides a common interface for users across all driver types.

From the Windows Start menu, navigate to Start→Programs→AudioScience and run the ASIControl program.



## 8 OPERATION USING ASICONTROL

Using ASIControl, the ASI6522 will look like so:

The screenshot shows the ASIControl (x64) application window with the following components:

- Adapter List Window:** A table at the top listing adapter details.
 

Type	Index	Name	Serial...	Rev	Firmwa...	MAC Address
	1	ASI6522	30399	B0	4.08.06	
- Adapter Topology Window:** A central diagram showing the internal connections of the ASI6522 #1 adapter, including four players, two recorders, two line outputs, two line inputs, two AES/EBU ports, and a clock source.
- Node Controls Window:** A panel on the right for configuring 'Adapter 1'.
 

Adapter Information	
Serial Number:	30399
Hardware Revision:	B0
DSP Software Version:	4.08.06
DSP Utilization:	00%

Adapter Mode	
Mode:	4-Play

SSX2 Mode	
Mode:	OFF

At the bottom of the window, the status bar shows: ASX v4.08.06, System v4.08.06, PCI/PCIe + Network Driver, and No Errors.

## 9 USER INTERFACE

ASIControl consists of three main windows: the adapter list in the top portion of the window, the adapter topology view on the left hand side, and the node control list on the right hand side.



### 9.1.1 Adapter List Window

The top portion of ASIControl shows a list of all the adapters that the application has found. By default, only bus based (i.e. PCI and/or PCI Express) adapters will be shown. If the network portion of the driver is installed (by selecting “Install Standard + Networked Audio Driver” after running the driver installer) and “Local PCI(e) + Networked adapters” is selected from ASIControl’s Options→Configure adapter interface, then AudioScience and other third party CobraNet devices will be shown.

Adapters are listed in order of adapter index. For bus-based adapters, this is determined by the adapter index jumper on the card. For AudioScience CobraNet devices this is calculated from the unit’s MAC address. Third party CobraNet devices are listed last as they have no AudioScience index.

### 9.1.2 Adapter Topology Window

The left hand side of ASIControl contains the topology view of the adapter. It is essentially a block diagram of the device showing the available physical inputs and outputs on the right hand side of the black, vertical ‘bus’ line. On the left hand side of the bus line, bus-based adapters show player and recorder streams, while CobraNet adapters show their network connections.

Each of the inputs and outputs is referred to as a node and each Node contains one or more controls. The topology shows each control as a small icon. A non-exhaustive list of nodes follows:

Line In	Recorder
Line Out	Tuner
AES/EBU In	Clock Source In
AES/EBU Out	CobraNet In
Player	CobraNet Out

Hovering the mouse over a particular node will highlight it. Clicking on a node will bring up the controls resident on that node in the right hand control list.

There is an adapter node in the top left corner of the topology window. Clicking on this will show adapter-specific controls and properties on the right hand side. Not all adapters have all nodes.

### 9.1.3 Node Controls Window

The right hand side of ASIControl shows the controls associated with the selected node in the topology view. The controls are arranged, from top to bottom, in order of audio signal flow, i.e. the audio signal can be viewed as entering the node at the top control and leaving at the bottom control. Controls may be used to either manipulate the audio as it passes through the node, or report back control status information.

For a comprehensive listing of controls and how to operate ASIControl, please see the ASIControl manual available from [www.audioscience.com](http://www.audioscience.com) and also installed by the driver. Not all adapters have all controls.

The section below lists some common and any specific controls, as seen in ASIControl, for this adapter.

### 9.1.4 Adapter Information

This control displays information about the installed AudioScience product.



## 9.1.5 Interface

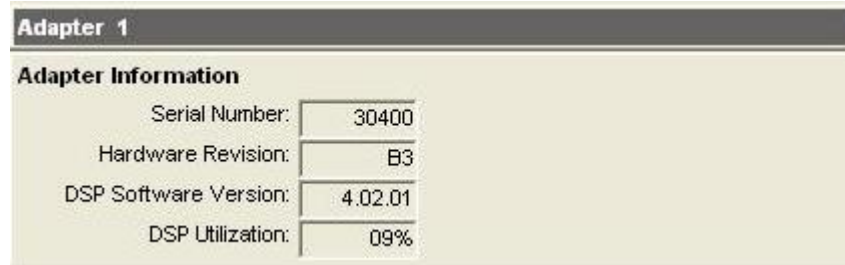

Adapter 1	
<b>Adapter Information</b>	
Serial Number:	30400
Hardware Revision:	B3
DSP Software Version:	4.02.01
DSP Utilization:	09%

**Figure 1. Adapter information seen in right side of ASIControl.**

### Serial Number:

The serial number is displayed here.

### Hardware Revision:

This lists the hardware revision of the AudioScience product.

### DSP Software Version:

The DSP software version is displayed; usually the same as the driver version installed.

### DSP Utilization:

This shows the loading of the AudioScience product's DSP in percent.

**Note:** Utilization should be kept below 90%.

## 9.2 Adapter Mode

The Adapter\_Mode control changes the number of players/recorders/lineouts that an adapter has. On certain adapters, not all sample rates/formats are supported; changing the mode of the adapter allows for best functionality with certain sample rates/formats. Different adapters will have different modes available, and not all adapters have modes. Please see datasheets on specific adapters, available at [www.audioscience.com](http://www.audioscience.com) for more.

### 9.2.1 Interface

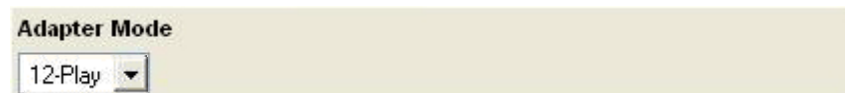

**Adapter Mode**

12-Play ▾

**Figure 2. Adapter Mode in ASIControl.**

Selecting the appropriate mode from the list using the dropdown arrow changes the Adapter\_Mode setting. A reboot is necessary after changing adapter mode. The mode setting is saved to the adapter's EEPROM.

The ASI6520/6522 support four adapter modes: 4-Play, 6-Play, Mono, and Low Latency.

#### 9.2.1.1 4-Play (default)

This mode supports 4 Play streams, 4 Record streams, and 4 Out streams with full mixing capabilities.

#### 9.2.1.2 6-Play

This mode supports 6 Play streams, 4 Record streams, and 2 Out streams with full mixing capabilities.

#### 9.2.1.3 Mono

NOTE: Driver 4.02.00 or later is required.

This mode supports 8 mono Play streams and 2 mono Record streams with full mixing capabilities. Mono mode supports mapping a single Play or Line\_In device to a single Line\_Out channel.

### 9.2.1.4 Low Latency

NOTE: Driver 4.06.00 or later is required.

This mode supports a single multichannel audio stream enabling live sound processing in ASIO and Core Audio applications. See the [Low Latency Mode datasheet](#) for further information.

## 9.3 Player

The Player control supports playback of an audio file from the computer's hard drive.

### 9.3.1 Interface

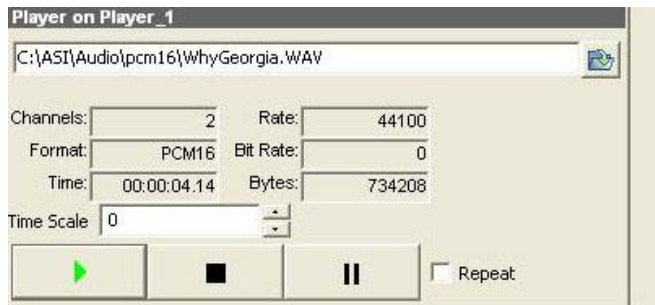

**Figure 3. A player in ASIOControl.**

The first line of static text contains the selected playback file. Below the filename is the file information; playback time and playback bytes, the timescale select options, the player control buttons and the file repeat option.

### 9.3.2 How To Play a File

The first step in playing a file is to select the file to play. Use the **file icon button** to navigate to the desired file. After opening the file, the complete filename, including the path, will appear immediately to the left of the file open icon. At this point the file information is also filled in so that it contains the following fields: **Channels**, **Rate**, **Format**, and **Bit Rate**. Most of these are self-explanatory. The **Rate** refers to the sample rate of the audio recorded in the file. The **Bit Rate** applies only to MPEG compression and is set to 0 for all other formats.

At this point the percentage time scaling without pitch shift can be set if desired. The default of 0 indicates that time scaling is disabled. The valid range of settings is +/- 20 percent.

The **Repeat** check box indicates whether the file should be played again after playback has completed. It can be set either before playback has begun, or while playback is underway.

The file is now ready to be played. To start playback press the **play button**. At this point the **Time** and **Bytes** fields report playback time and the number of bytes of the file that have been played.

Once playback has started, the **stop** and **pause buttons** can be used to stop or pause the playback.

### 9.3.3 Using embedded sine wave generator

Manually typing in a filename of "~" and pressing play will cause a full-scale 1 kHz sine wave to be played at 48 kHz. The format of the filename string is: "-w, c,f,a,m,s,t".

**w** = waveform = SINE (default=SINE)  
**c** = channels = 1...8 (default = 2)  
**f** = frequency = 1000 for 1kHz (default=1000)  
**a** = amplitude = -1 for -1dBFS (default=0dBFS, i.e. full scale)  
**m** = channel mask = 10 for left only, 01 for right only, 11 for stereo, etc. (default=1 for all channels)  
**t** = sample type = (PCM8, PCM16, PCM24, PCM32, FLOAT32) (default=FLOAT32)  
**s** = sample rate = positive integer (default=48000) [validity depends on adapter]

Defaults can be used if the complete string is not specified, i.e.

"~" becomes "~wSINE,c2,f1000,a0,m11,s48000,tFLOAT32"

Any subset of the options may be specified, the remaining options will be set to the defaults. e.g. "~f500" = 500Hz stereo sine wave at 0dBFS, 48kHz sample rate.

### 9.3.4 Developer

#### 9.3.4.1 Windows APIs

**Wave** – waveOutOpen(), waveOutWrite(), waveOutClose() etc.

**HPI** – Output stream functions documented [here](#).

**ASX** – ASX Player control functions documented [here](#).

**DirectSound** – TBD.

#### 9.3.4.2 Linux APIs

**HPI** – TBD

## 9.4 Recorder

The Recorder control supports recording of an audio file.

### 9.4.1 Interface

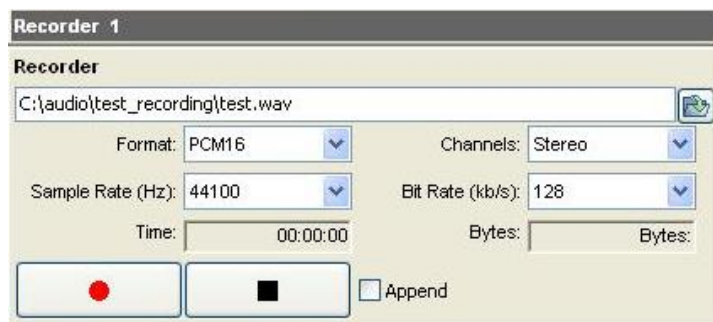

**Figure 8. A recorder in ASIControl.**

The first line of text contains the name given to the recorded file along with the location where it is to be saved. Below the filename is the file information, the record time and record bytes, the recorder control buttons and the file Append option.

### 9.4.2 How To Record a File

The first step in recording a file is to have audio coming into the adapter. This can be from a line-in or from one of the players in ASIControl. See appropriate sections in this datasheet to accomplish this. Next, the new file needs a name and place to be saved, or an existing audio file can be selected to be overwritten or appended to. Use the **file icon button** to navigate to the location to create the file and to give it a name, or to open a previously recorded file to overwrite or append to it. Next, from the dropdown arrows, select the number of "**Channels**", the "**Sample Rate**", the "**Format**", and the "**Bitrate**" that the file should be recorded in.

Check the **Append** checkbox to save the audio to the end of an already existing file.

The file is now ready to be recorded. To start recording, press the **record button**. At this point the "**Time**" and "**Bytes**" fields report record time and the number of bytes of the file that have been recorded.

Once recording has started, the **stop** and **pause buttons** can be used to stop or pause the playback.

## 9.4.3 Developer

### 9.4.3.1 Windows APIs

**Wave** – use `waveInOpen()`, `waveInStart()` etc.

**HPI** – use `HPI_InStreamxxx()` functions.

**ASX** – use `ASX_Recorder_xxx()` functions.

### 9.4.3.2 Linux APIs

**HPI** – use `HPI_InStreamxxx()` functions.

**ASX** – use `ASX_Recorder_xxx()` functions.

## 10 AUDIO FORMATS

The ASI6520 and ASI6522 support the following audio recording formats:

Format	HPI format	Windows format
8 bit unsigned PCM	HPI_FORMAT_PCM8_UNSIGNED	WAVE_FORMAT_PCM, wBitsPerSample=8
16 bit signed PCM	HPI_FORMAT_PCM16_SIGNED	WAVE_FORMAT_PCM, wBitsPerSample=16
32 bit floating point PCM (+/- 1.0)	HPI_FORMAT_PCM32_FLOAT	WAVE_FORMAT_IEEE_FLOAT
MPEG-1 Layer 2	HPI_FORMAT_MPEG_L2	WAVE_FORMAT_MPEG -fwHeadLayer=ACM_MPEG_LAYER2 -fwHeadMode=ACM_MPEG_SINGLECHANNEL, ACM_MPEG_DUALCHANNEL, ACM_MPEG_STEREO
MPEG-1 Layer 3 (MP3)	HPI_FORMAT_MPEG_L3	WAVE_FORMAT_MPEG -fwHeadLayer=ACM_MPEG_LAYER3 -fwHeadMode=ACM_MPEG_SINGLECHANNEL, ACM_MPEG_DUALCHANNEL, ACM_MPEG_STEREO  OR  WAVE_FORMAT_MPEGLAYER3

Cards do not support 8 channels of MP3 recording.

NOTE – for maximum efficiency, you must use one sample rate for all streams and set the global sample rate of the card to this rate.

## 10.1 Volume

The Volume control allows the audio signal's gain to be altered in the range of -100 to +20dB.

### 10.1.1 Interface

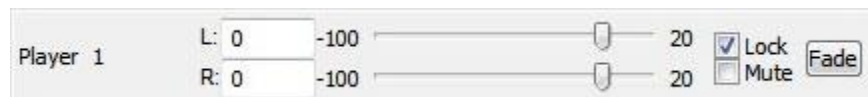

**Figure 6. A Volume of a Player in ASiControl.**

**Left and Right** display boxes:

Displays the gain settings that the slider bars are set to.

**Slider Bars:**

Click on the bar with the mouse and drag to desired gain. Once the bars are selected, the left and right arrow keys can also be used to change the settings.

**Lock:**

When checked, locks the left and right channels to the same gain value. When unchecked, allows the left and right channels to have independent gains. (Note that if an adapter is in SXX2 mode, the Player volumes cannot be unlocked to move the left and right channels independently.)

**Mute:**

Check this box to mute the volume.

**Fade:**

When pressed, automatically fades the volume to the opposite end of the scale.

## 10.1.2 Developer

### 10.1.2.1 Windows APIs

**Wave/Mixer** – MIXERCONTROL\_CONTROLTYPE\_VOLUME

This is a Windows standard volume control. Settings are in the range of 0 to 65535, where 0 completely mutes the output and 65535 is the maximum volume.

**HPI** – [HPI\\_Volume](#) APIs.

**ASX** – [ASX\\_Volume](#) APIs.

**DirectSound** – TBD.

### 10.1.2.2 Linux APIs

**HPI** – [HPI\\_Volume](#) APIs.

**ASX** – [ASX\\_Volume](#) APIs.

**ALSA** – TBD.

## 10.2 Meter

Meters in ASIControl are located on audio nodes and display the audio level as the audio signal passes through the node. Most AudioScience devices return both RMS and peak level readings and ASIControl displays both simultaneously.

### 10.2.1 Interface

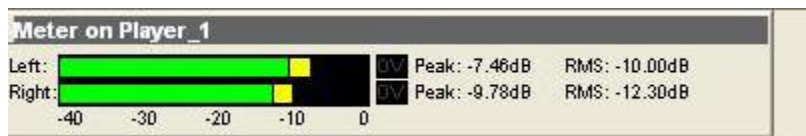

**Figure 7. A stereo peak meter display. The RMS is the green bar and the peak is the yellow bar.**

To the right of the peak meter is the absolute readings in dBFS. These can be useful when testing input tones of a specific known level.

### 10.2.2 Developer

#### 10.2.2.1 Windows APIs

**Wave/Mixer** – Meters are read using `mixerGetControlDetails()` on a control of type signed and with type “Peak” the name “Peak Meter”. A minimum value is 0 and maximum is 32767. The interface returns the peak readings only, not the RSM level. It confirms to expected Windows functionality.

**HPI** – Meters are read using the [HPI\\_Meterxxx\(\)](#) API.

**ASX** – Meters are read using the [ASX\\_Meter\\_xxx\(\)](#) API.

**DirectSound** – TBD.

#### 10.2.2.2 Linux APIs

**HPI** – Meters are read using the [HPI\\_Meterxxx\(\)](#) API.

**ASX** – Meters are read using the [ASX\\_Meter\\_xxx\(\)](#) API.

**ALSA** – TBD.

## 10.3 Channel\_Mode

The channel mode is a mechanism for handling mono to stereo conversions and directing the output to either left or right channels, as well as outputting left to stereo and right to stereo.

### 10.3.1 Interface

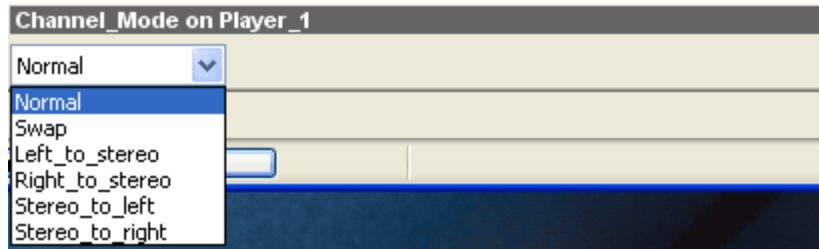
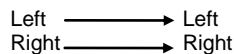

**Figure 4. ASIControl view of a player's channel mode control.**

Default playback of either mono or stereo files causes audio to be output from the player on both the left and right audio channels. The channel mode control can allow the audio to be directed to either the left only or the right only. Select a channel mode setting from the dropdown list.

Valid settings are:

**Normal** – left channel out left channel, right channel out right channel



**Swap** – left channel out right channel and right channel out left channel



**Left\_to\_stereo** – left channel out to both left and right channels

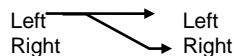

**Right\_to\_stereo** – right channel out to both left and right channels

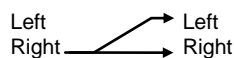

**Stereo\_to\_left** – left and right channels out to left channel

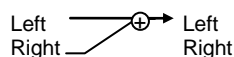

**Stereo\_to\_right** – left and right channels out to right channel

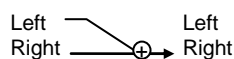

The Stereo\_to\_left and Stereo\_to\_right operations perform a sum of the left and right channels and then divides the result by 2.

## 10.4 ClockSourceIn

In the topology pane of ASIControl, click on Clock Source 1

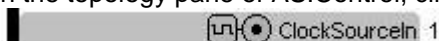

and in the node pane, select where the adapter is to get its clock source from using the Clock Source dropdown list, as well as the sample rate to use if clocking from adapter.

**Note** that for CobraNet and Livewire devices, the sample rate is fixed at 48kHz.

### 10.4.1 Interface



**Figure 5. Clock Source information as seen in ASIControl.**

**Local Rate:**

Select from the dropdown list the supported rates of the adapter.

**Clock Source:**

From the dropdown list, select the source for the adapter's clocking. Selections, depending on the adapter, include:

- Local – adapter rate is used; select a supported sample rate in Local Rate dropdown list
- Word – Word clock from Word clock BNC connector on digital cable loom (or BOB1024)
- WordHeader – Word clock from header on adapter (ASI61xx only)
- AES/EBU Sync – AES/EBU Sync from AES/EBU Sync XLR connector on digital cable loom (or BOB1024)
- AES/EBU In 1-4 – rate taken from specific digital input
- AES/EBU Auto – rate taken from first valid digital input; looks at digital input 1 first, then up to digital input 4
- Blu link

**Adapter Rate:**

<end>